

3094777 RE / (St.: 04.2016) 04.2016

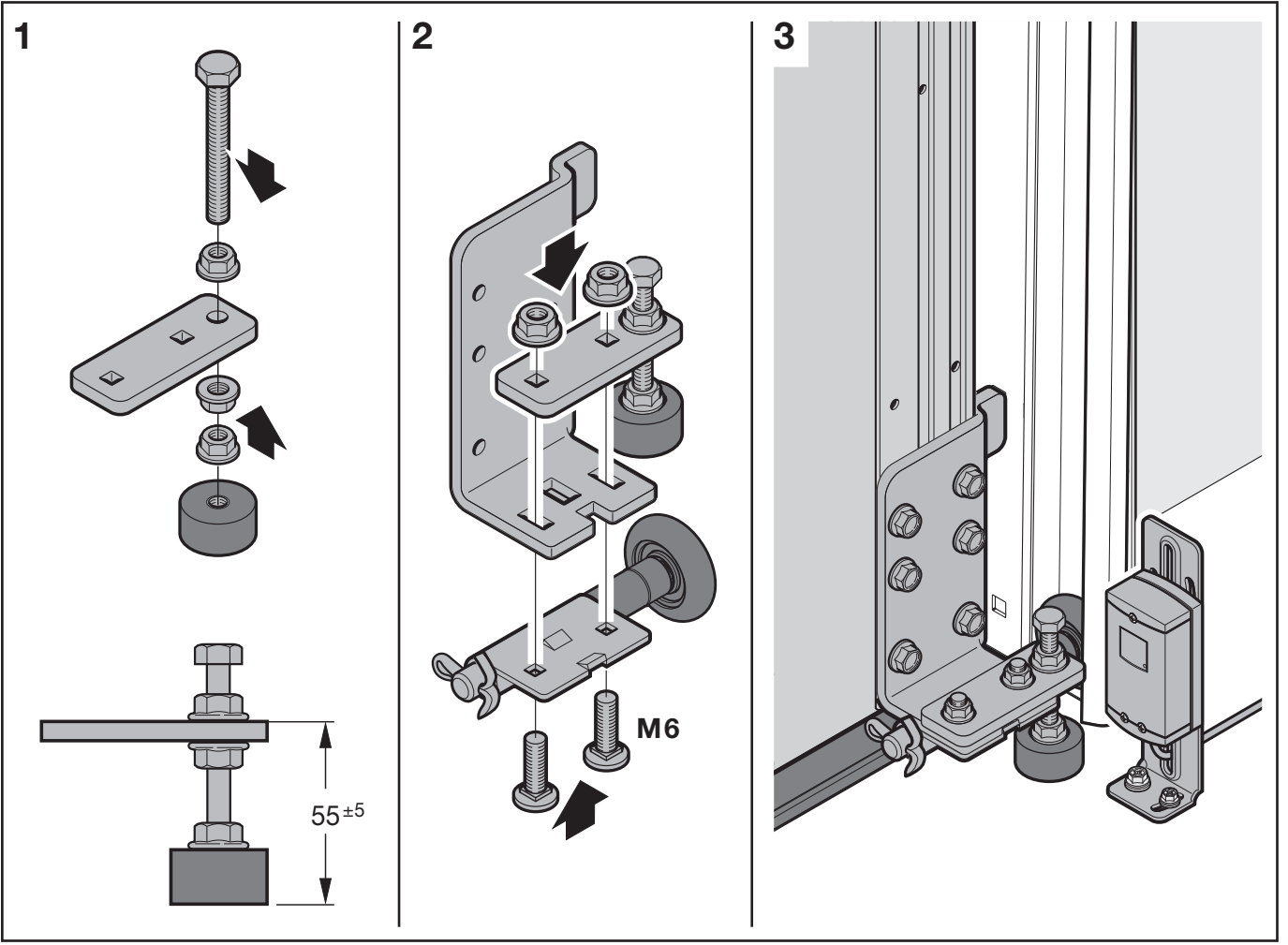

3094777 RE / (St.: 04.2016) 04.2016

